

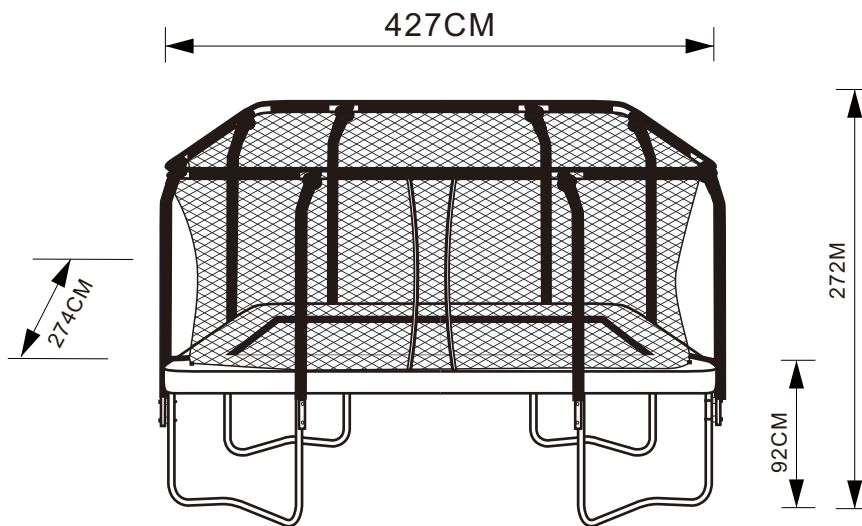

# Trampoline med sikkerhetsnett

## Monteringsinstruksjoner





[www.coop.no](http://www.coop.no)





## ADVARSEL

Bare én bruker om gangen.  
Kollisjonsfare. En voksen skal alltid holde oppsyn.  
Saltoer ikke tillatt.  
Lukk alltid åpningen i nettet før du hopper.  
Les instruksjonen.  
Nettet bør skiftes annethvert år.  
Feil bruk av denne trampolinen kan føre til alvorlig personskade.  
Undersøk trampolinen før bruk og erstatt eventuelle slitte, defekte eller manglende deler.  
Overhold alle sikkerhetskrav som følger med dette produktet. Ikke egnet for barn under tre år, på grunn av manglende ferdigheter.  
Trampolinen er beregnet på private husholdninger.  
Skal kun brukes utendørs.





Les alle sikkerhetsinstruksjonene og hele monteringsveiledningen før trampolinen brukes, og ta vare på dem for fremtidig referanse.

Vi anbefaler at dere er to personer når dere setter opp trampolinen.

Det trengs også minst to personer for å flytte trampolinen etter at den er montert. Løft trampolinen forsiktig, hold den vannrett og bær den dit dere vil ha den.

Hvis trampolinen skal flyttes langt, bør den tas fra hverandre og settes sammen igjen for å unngå at den blir skadet.

Hvis trampolinen skal stå ubrukt over lengre tid, bør den demonteres og settes bort. Oppbevares på et tørt sted.

Følg monteringsveiledningen nøye.

### Sikkerhetsinstruksjoner:

Denne trampolinen er beregnet på private husholdninger og skal bare brukes utendørs. Eieren eller personen som holder oppsyn, er ansvarlig for at alle som bruker trampolinen, er tilstrekkelig informert om alle sikkerhetsinstruksjonene og riktig bruk av trampolinen!

- Sikkerhetsinstruksjoner  
**Maksimumsbelastning: 150 kg**
- Trampolinen skal bare brukes av én person om gangen. Den er ikke konstruert for flere enn én!
- Trampolinen må aldri brukes av to personer samtidig! Dette øker risikoen for personskader, som kan være så alvorlige som en brukket nakke og lammelser.
- Unngå saltoer! Saltoer øker risikoen for å lande på hodet eller nakken, noe som kan medføre alvorlige skader eller død
- Bruk ikke trampolinen i lange perioder om gangen (ta regelmessige pauser)
- Hopp i midten av trampolinematten. Å treffe polstringen i kanten av trampolinen kan medføre skader, siden denne ikke er konstruert for å hoppes eller tråkkes på.
- Vær alltid forsiktig når du klatrer opp på trampolinen, så du ikke setter deg fast i fjærene eller treffer rammen.
- Pass alltid på at polstringen i kanten ligger riktig og dekker rammen og fjærene, for å unngå skade. Ikke hopp ned fra trampolinen. Klatre forsiktig ned for å unngå skade.
- Alle som bruker trampolinen, bør kjenne sine egne begrensninger. Risikoen for alvorlige skader må tas på alvor. Det er viktig å bøye i knærne når du lander, slik at du får best mulig kontroll. Hopp opp og ned på samme sted – dette gir best kontroll.
- Sikt på midtmarkeringen. Oppnå full kontroll på hoppene dine før du prøver deg på mer vanskelige hopp.
- Bruk ikke trampolinen hvis du er påvirket av alkohol, medisin eller andre medikamenter. Dette øker risikoen for skader dramatisk, siden koordineringsevnen, dømmekraften og reaksjonstiden blir påvirket.
- Ikke røyk når du bruker trampolinen.
- Bruk ikke trampolinen hvis du har høyt blodtrykk.
- Bruk ikke trampolinen hvis du er gravid.





- Hopp aldri ned på trampolinen fra et tak eller andre høye steder. Dette øker risikoen for skader.
- Dra deg ikke opp på trampolinen ved å ta tak i kantpolstringen.
- Bruk ikke trampolinen hvis den er våt. Trampolinematten blir glatt, og dette øker risikoen for at hopperen kan falle og skade seg.
- Bruk ikke trampolinen i kraftig vind. Dette kan føre til at hopperen mister balansen og blir alvorlig skadet. Undersøk trampolinen for feil HVER gang den skal brukes.
- Stram til skjøter og sammenkoblinger og kontroller regelmessig at alle knuter sitter godt.
- Slitte eller defekte deler må skiftes. Korriger eventuelle feil. Sørg for at trampolinen er fri for alger, jord osv.
- Bruk ikke sko, støvler eller annet fottøy på trampolinen.
- Pass på at det ikke er noen skarpe gjenstander på klærne eller i lommene når trampolinen brukes.
- La ikke kjæledyr komme opp på trampolinen. Skarpe klør kan skade trampolinematten. Hvis dere bruker en stige for å komme opp på og ned av trampolinen, skal ikke trampolinen brukes uten tilsyn!
- Fjern om mulig stigen.
- Ikke bruk trampolinen i mørke.



**Maksimal brukervekt 150 kg**

Uegnet for barn under tre år, på grunn av manglende ferdigheter.

Hvis du har helseproblemer, bør du rådføre deg med legen din om hva slags fysisk aktivitet du kan utføre.



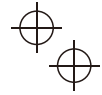

- Pass på at glidelåsen på sikkerhetsnettet alltid er lukket når trampolinen brukes.
- Husk at nettet ikke er laget for at man skal hoppe inn i det, for f.eks. å få mer fart!
- Kontroller regelmessig at sikkerhetsnettet sitter som det skal.
- Stram til skjøter og sammenkoblinger.
- Undersøk trampolinen og sikkerhetsnettet for feil og skader HVER gang trampolinen skal brukes. Stram til skjøter og sammenkoblinger og kontroller regelmessig at alle knuter sitter godt.
- Et visst vedlikehold må utføres før trampolinen tas i bruk om våren.
- Regelmessig vedlikehold er påkrevd. Hvis regelmessig vedlikehold forsømmes, kan det medføre risiko for brukerne.
- Kontroller at alle muttere og bolter sitter godt, og trekk dem til når det er nødvendig.
- Kontroller at alle fjærer og fjærfester er intakte og ikke kan løsne under lek.
- Bare én bruker om gangen på grunn av kollisjonsfaren.
- Saltoer er ikke tillatt.
- En voksen skal alltid holde oppsyn.
- Kontroller alle dekker for bolter og skarpe kanter, og skift dem om nødvendig.

#### Plassering av trampolinen:

- Det må være minst 7,3 meter fri høyde over trampolinen, altså ingen gjenstander av noe slag i dette området.
- Trampolinen skal stå på en flat og vannrett overflate.
- Overflaten må ikke bestå av betong, stein, fliser eller asfalt.
- Det må aldri plasseres noen gjenstander under trampolinen.
- Trampolinen skal stå i god avstand (minst 2,5 meter) fra elektriske ledninger, svømmebasseng, gjerder, trær og greiner, klatrestativer og andre gjenstander.

#### Vedlikehold:

- Rengjør trampolinematten med en fuktig klut for å fjerne alger, smuss osv. Tørk deretter over med en tørr klut. Bruk ikke trampolinen før den er helt tørr. Bruk ikke rengjøringsmidler eller andre kjemikalier til å rengjøre produktet. Stram alle skjøter og sammenkoblinger regelmessig, og forsikre deg om at matten er riktig montert.

#### Annen informasjon:

- Vi anbefaler å sikre trampolinen i sterk vind. Bind trampolinen fast med tau som festes til trampolinematten.
- Sikre trampolinen på minst tre punkter i jevn avstand fra hverandre. La være å sikre bena, siden disse kan bli skjeve slik at trampolinen blir ødelagt. Demonter eller fjern om nødvendig trampolinen helt. I kraftig vind kan en usikret trampoline representere en stor fare.

#### Annen informasjon:

Trampolinen og sikkerhetsnettet skal være pakket vekk om vinteren. Pass på at alle deler er tørre og trygt pakket. Oppbevares på et tørt sted. Vær oppmerksom på at vind og vær kan forringe produktet.



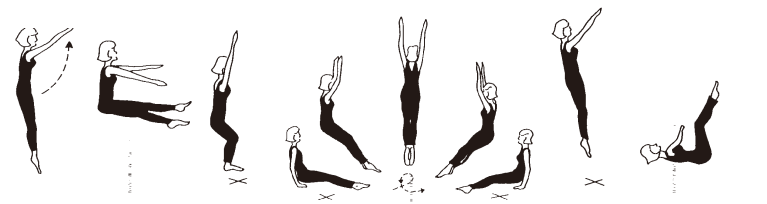
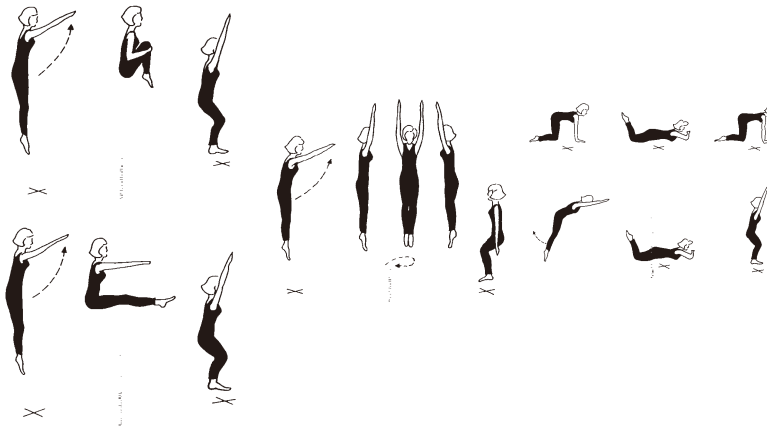
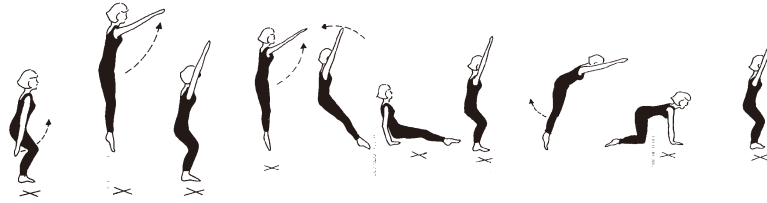

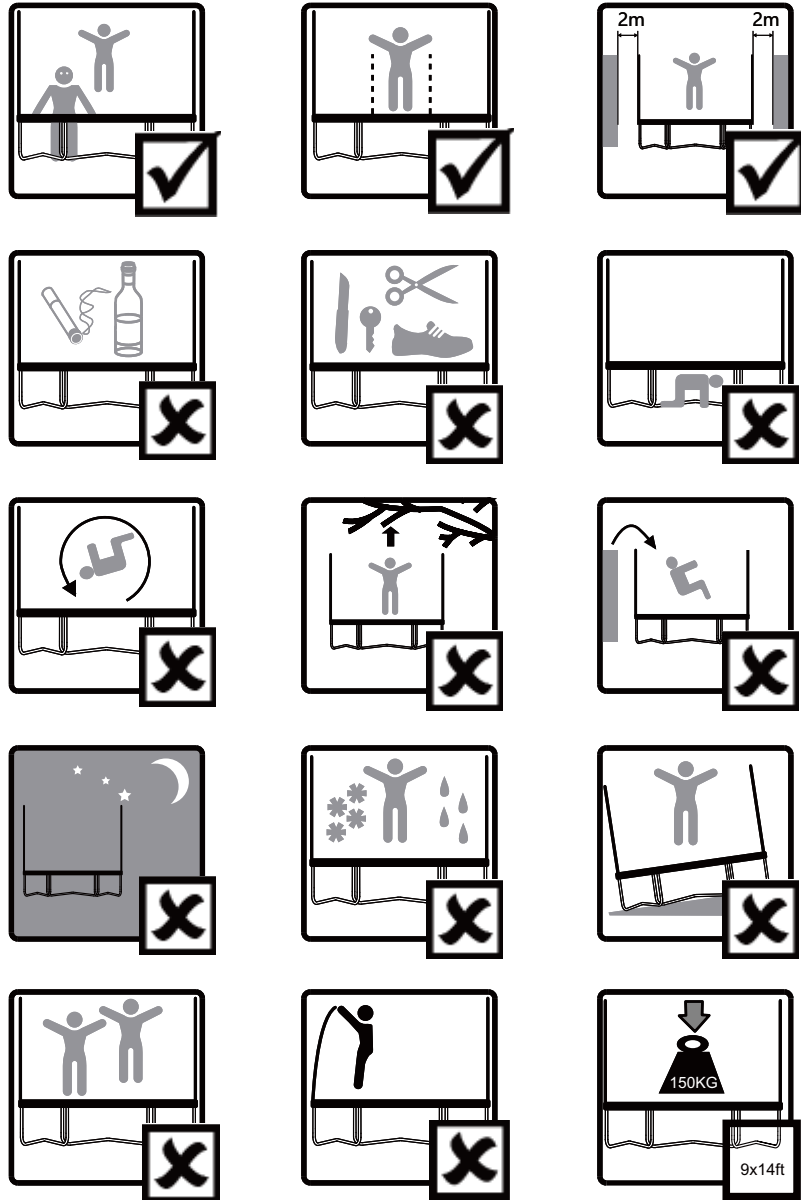
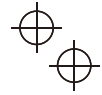



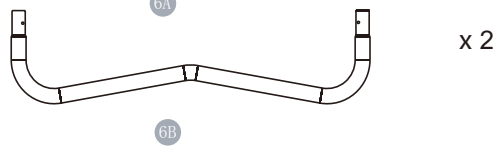
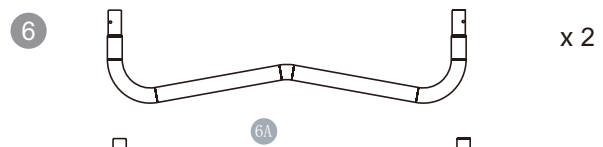
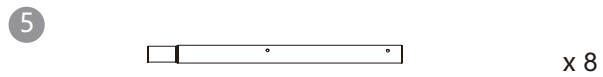
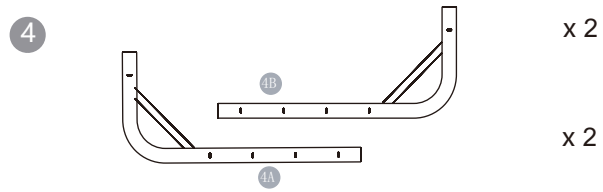
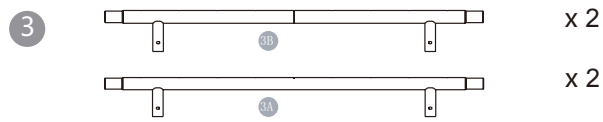
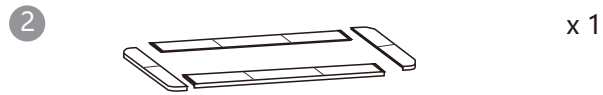
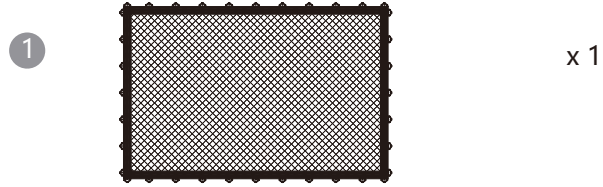







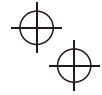



7		x 92
8		x 18
9		x 8
10		x 8
11		x 16
12		x 16
13		x 8
14		x 1
15		x 8





- 16  x 8
- 17  x 8
- 18  x 4
- 19  x 6  
 x 2  
 19A  
 19B
- 20  x 4  
 x 2  
 20A  
 20B
- 21  x 4

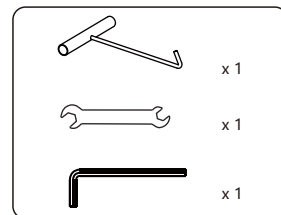

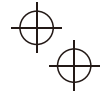

1

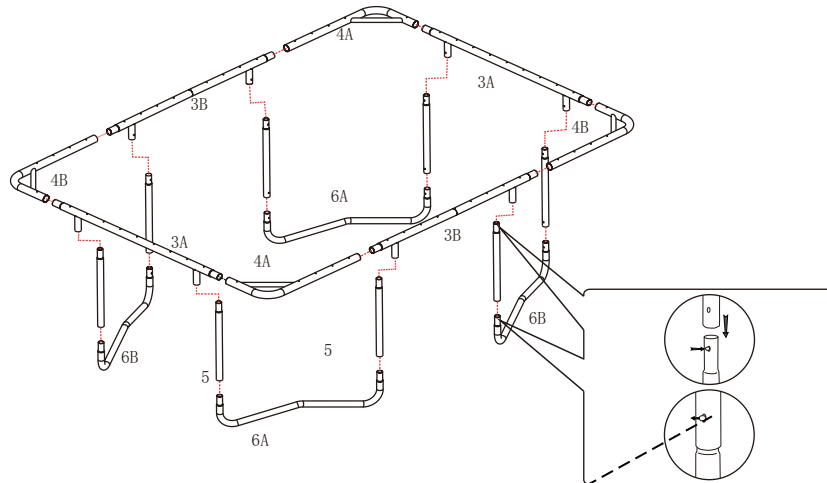

Påse at hurtigklipsen har retning innover

2

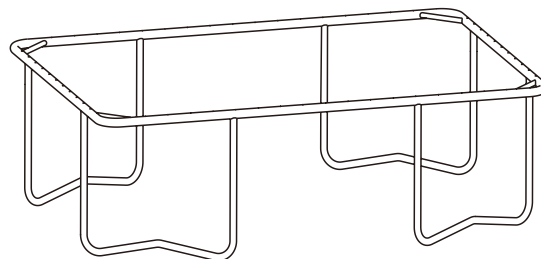

10

[www.coop.no](http://www.coop.no)





3

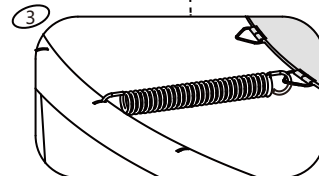
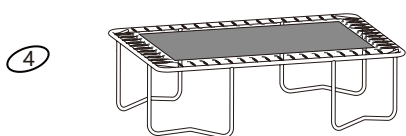
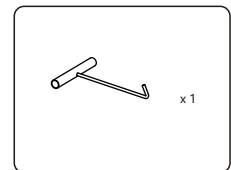
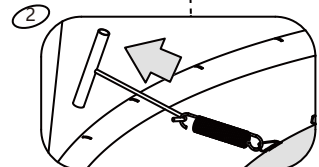
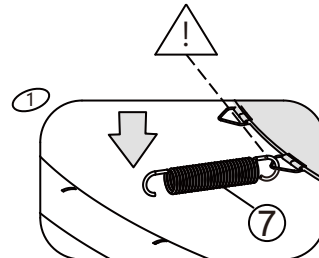
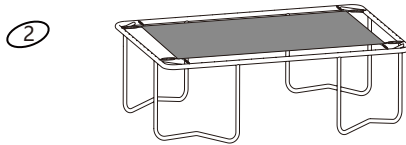
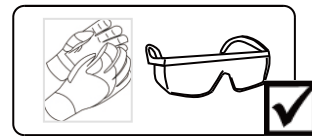
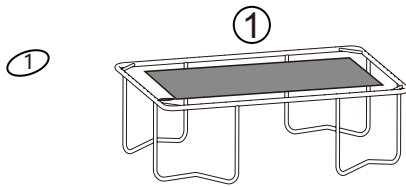
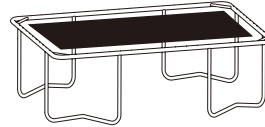
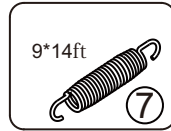

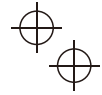

4

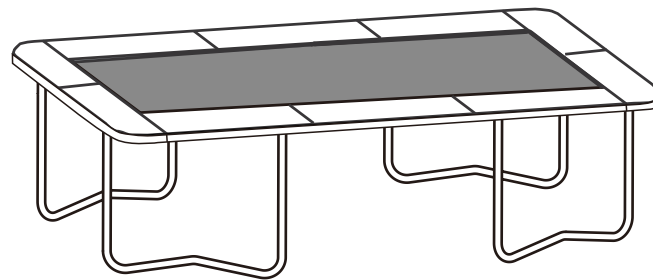
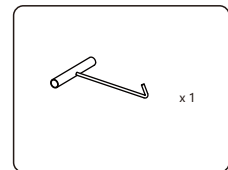
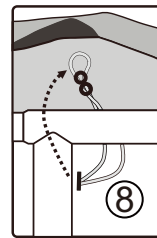
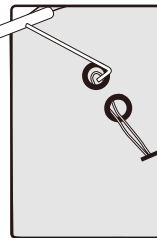
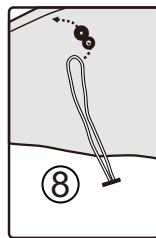
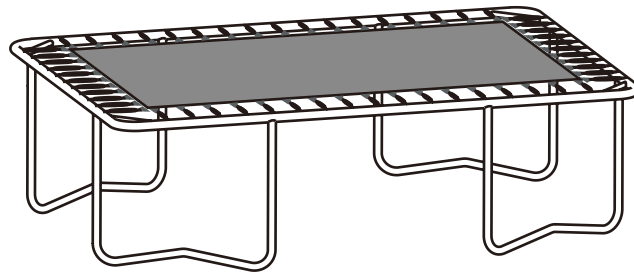
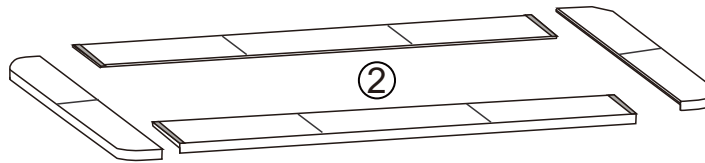



5

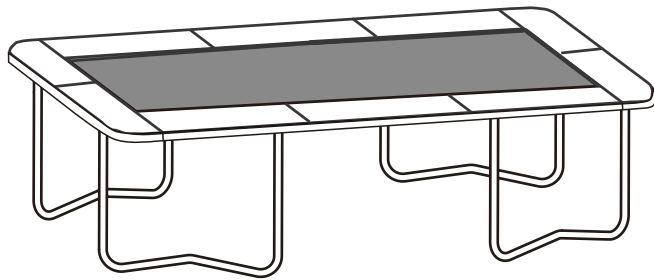

13





6

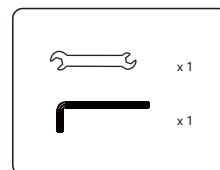
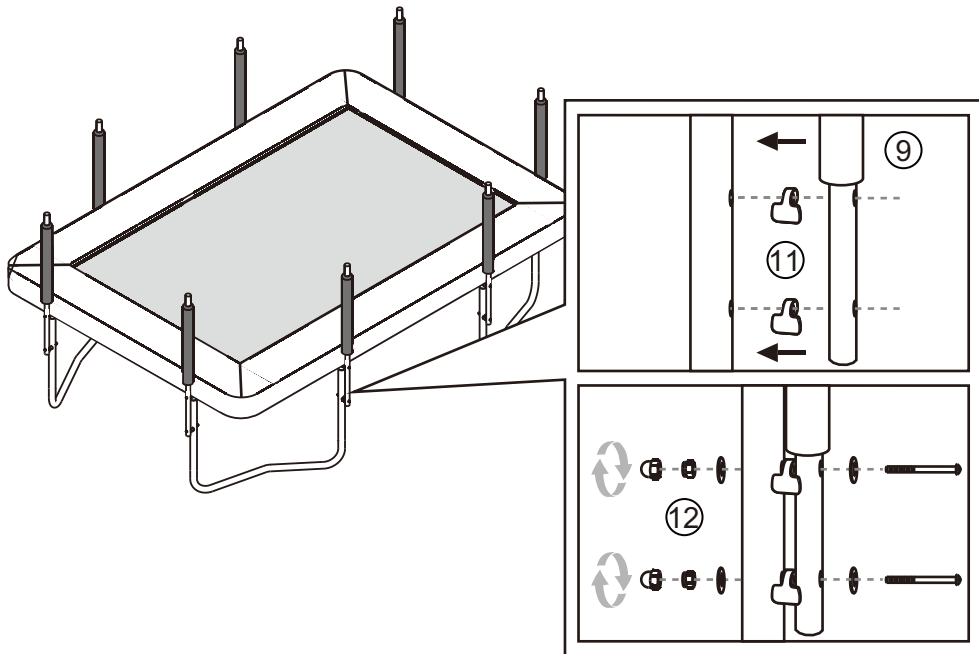





7

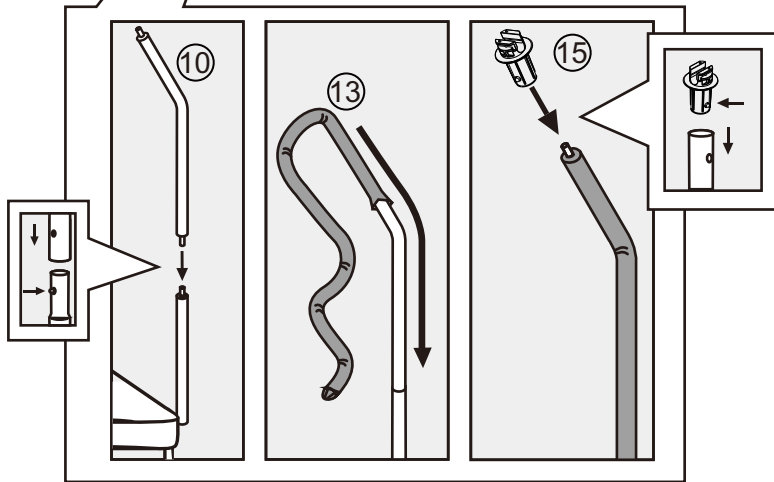
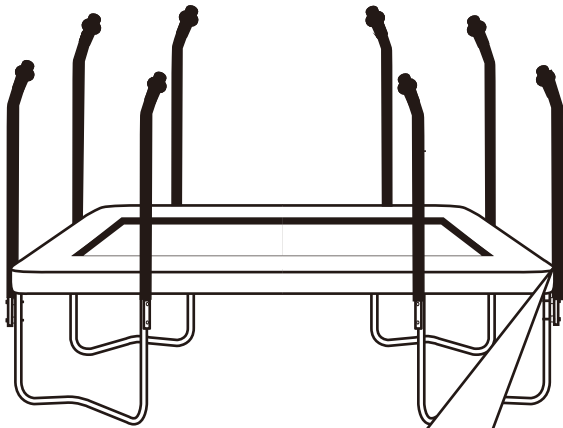

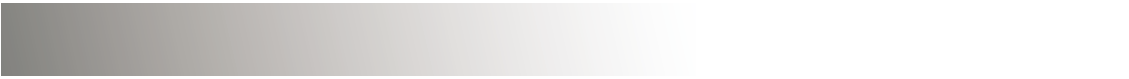

8

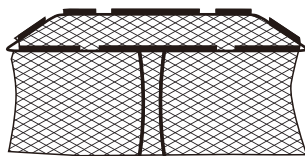
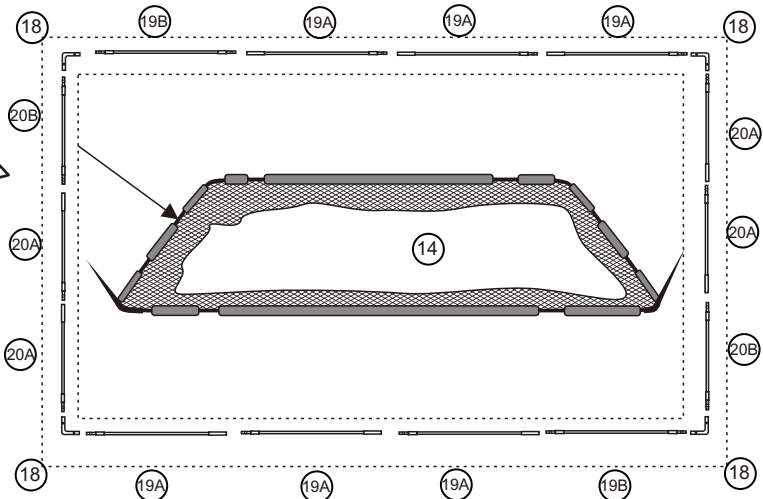
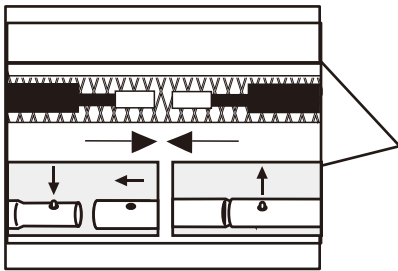
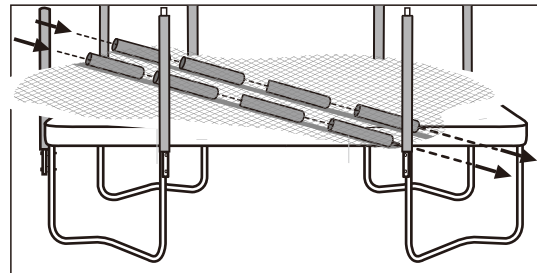
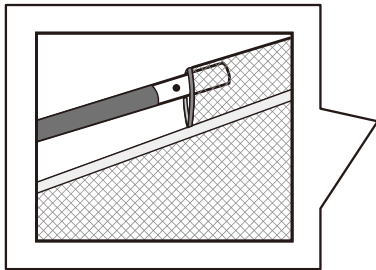

14

18



x 4



19A

x 6



19B

x 2



20A

x 4



20B

x 2

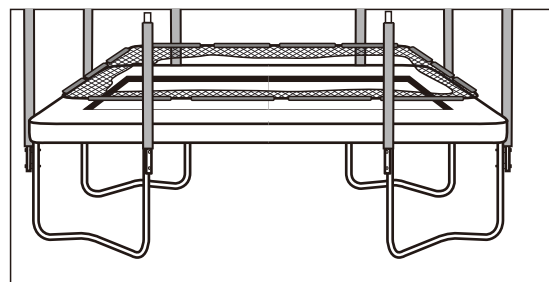

16

[www.coop.no](http://www.coop.no)



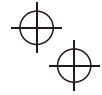

9

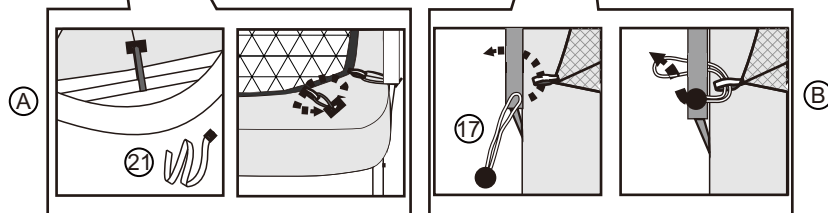
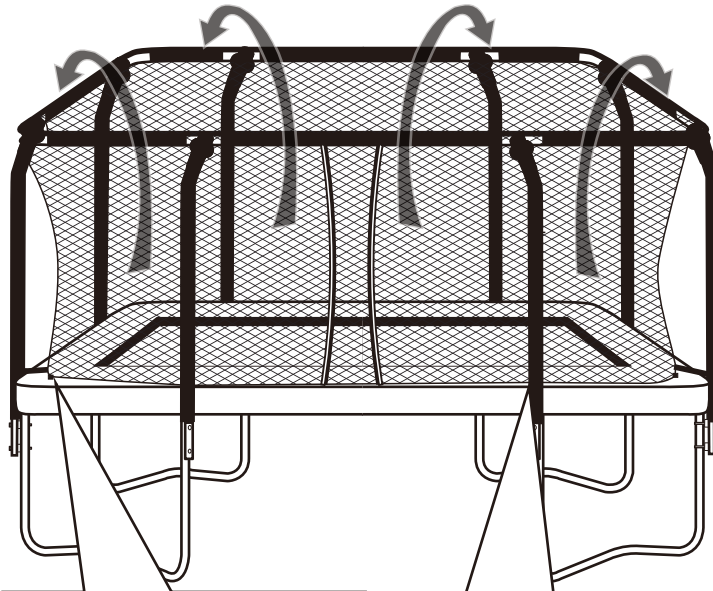
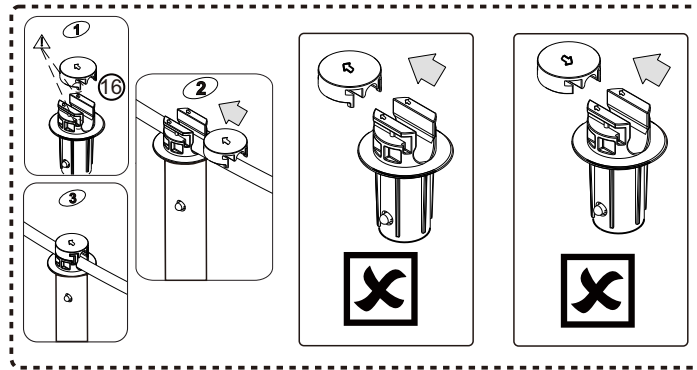

Monter stropper i 4 hjørner først (A) så strikker på de 8 stolpene (B)





10

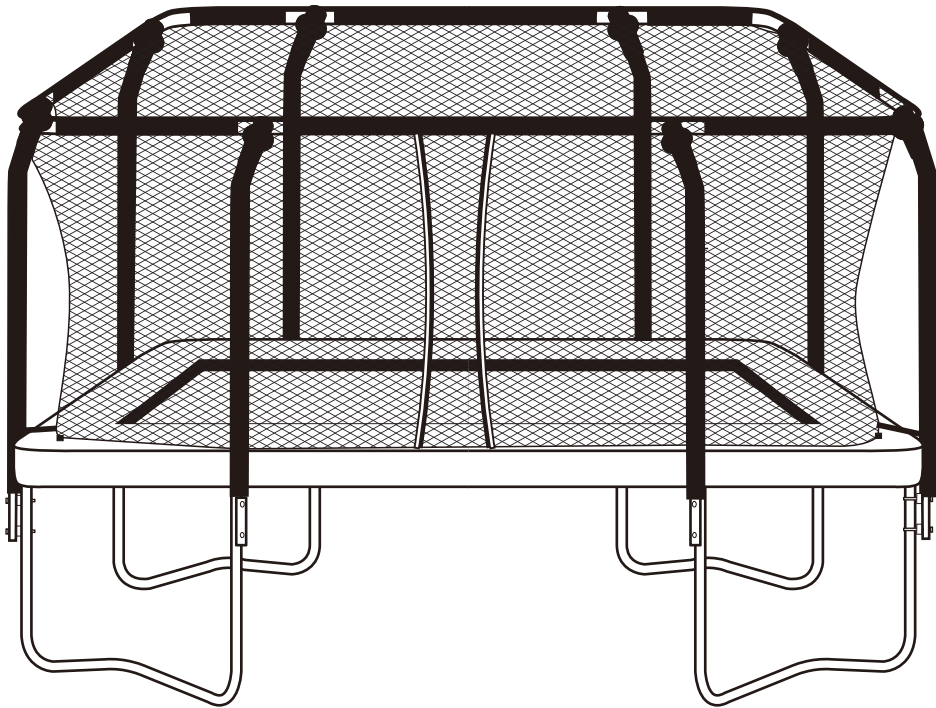

18

[www.coop.no](http://www.coop.no)





  
**ProFlyer**





**coop** Forbrukerkontakt:  
Faghandel servicesenter  
E-post: [faghandel.servicesenter@coop.no](mailto:faghandel.servicesenter@coop.no)  
Telefon: 24174000  
[www.coop.no](http://www.coop.no)

Produsert i Kina  
For Coop Norge SA - Faghandel  
Regnbueveien 5, N-1405 Langhus - Norway  
T. 64 87 50 00 - [www.coop.no](http://www.coop.no)  
**coop**

